

MAGNALUX

40W LED Wall Pack



Specification

Model	VPL-WPA-40WAN-YYK
Power	40W
Luminous Efficiency	110-120lm/w
Voltage	AC100-277V/347~480V
Frequency	50/60Hz
PF	>0.95
CCT	3000-6500K
CRI	70/80Ra
Beam Angle	Half cutoff
Housing Material	AL+PC
Working Temperature	-40°C ~ +60°C
Life Span	>50,000hrs
Warranty	5 years
Certificate	DLC ETL CE RoHs

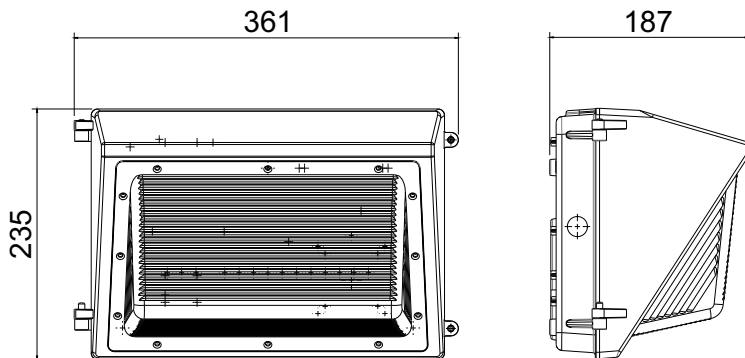

Characteristics

- High luminous efficiency 110~120lm/w and long life>50,000hrs
- Universal voltage AC100~277V and 347~480V available
- Die-casting cooling design, better cooling light quality, LED Tj< 65°C
- Excellent optical design, greatly improve the light utilization and evenness.
- Available with dust to dawn photocell sensor
- IP65 rating for outdoor use